

FDV

Dense Pro 1200mm

El nr	32 416 11
Article nr	364089
EAN	7090015377108

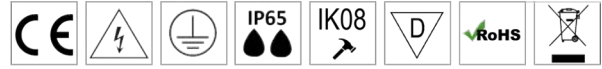

Lysteknikk

Type lyskilde	SMD LED
Spenning	230VAC 50/60Hz
Watt	25W-32W-38W-45W
Systemeffekt (W)	25W-32W-38W-45W
Effektiv lysstrøm (lm)	4000-5120-6080-7200 lm
Effekt	160lm/W
Fargetemperatur	4000K
Fargegjengivelse (CRI)	Ra>80
MacAdams faktor	SDCM≤3
Levetid (IEC 62717 Ta25)	118 000h L80B50
Lysspredning	120°
Driftstemperatur	-20°C <ta< 40°C

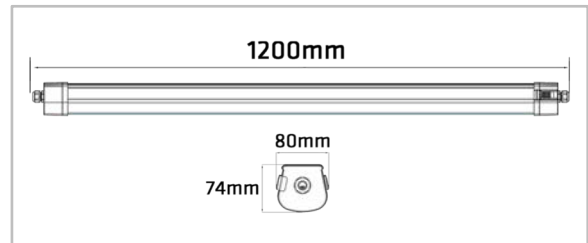
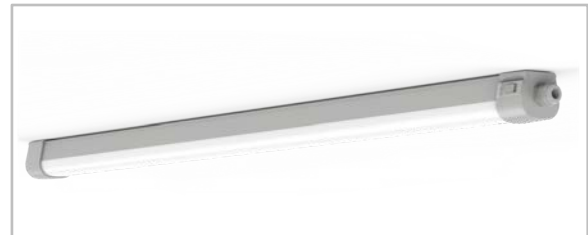

LED Driver

Type	Ikke Dimbar
Driftsstrøm	350mA Konstantstrøm

Beskyttelse

Isolasjonsklasse	Klasse I
IP-grad (armaturhus)	IP65
IK-grad	IK08

Materialer og overflater

Armaturhus	Polycarbonate
Farge	Grå (RAL7035)

Energi og godkjenning

Inneholder lyskilde med Energiklasse	B
Godkjenning	CE, ENEC, RoHS, D mark
Safety standard	EN IEC 60598-2-1:2021
EMC standard	EN IEC 55015: 2019+A11:2020, EN 61547: 2009

Maks. Armaturer per sikring

B10	B16	C10	C16
20	32	33	53

Montering/Tilkobling

Montering	Utenpåliggende
Kobling	Hurtigklemme

Dimensjoner (mm)

Lengde (L)	1200 mm
Høyde (H)	74 mm
Bredde (W)	80 mm
Vekt	1,38 kgs

Forpakning

Eske dimensjon	1300x90x80 mm
Eske Vekt	1,60 kgs
Kartong Dimensjon	1330x300x200 mm
Antall/Kartong	6 stk
Kartong Vekt	10,50 kgs

Dense Pro 1200mm/1500mm

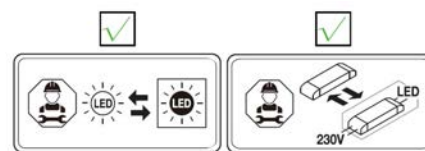
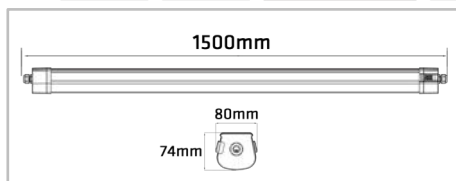
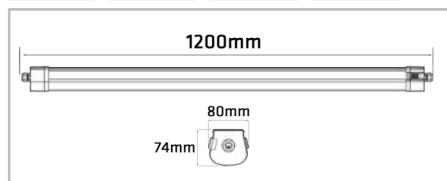
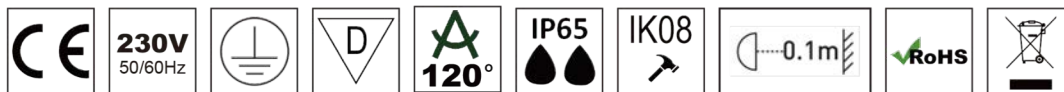

IMPORTANT INFORMATION:

1. Please read this instruction carefully before installation and keep it for future reference.
2. Please conform to the instruction of equipment and installed by professional.
3. Make sure correct voltage applied before use and keep away from heat and vibration source.
4. The light source of this luminaire is not replaceable. When the light source reaches its end of life the whole luminaire shall be replaced.
5. The product is not suitable for any oil pollution ambient or related applications.
6. This product contains a light source of energy efficiency class **B**.
7. It shall not be disposed of as unsorted municipal waste.
8. For indoor and outdoor use under shelter.

MAIN PARAMETER:

Product	364089	365089	365189 DALI
Rated Voltage	AC 220-240V 50/60Hz	AC 220-240V 50/60Hz	AC 220-240V 50/60Hz
LED watt	25W-32W-38W-45W	35W-44W-53W-63W	63W
System eff	45W	63W	63W
LED	LED SMD 2835	LED SMD 2835	LED SMD 2835
LED Driver	Constant Current 350mA	Constant Current 350mA	Constant Current 1200mA
Color Temperature	4000K	4000K	4000K
Protection	Class I	Class I	Class I
Beam Angle	120°	120°	120°
IP Rated	IP65	IP65	IP65
Operation Temperature	-20°C <ta<40°C	-20°C <ta<40°C	-20°C <ta<40°C
Product Size	1200mmx80mmx74mm	1500mmx80mmx74mm	1500mmx80mmx74mm

INSTALLATION INSTRUCTIONS:

1. Always switch off the power supply before installation.
2. Make sure all parts are ready when open the box and prepare the installation tools the lighting needs.
3. Should be installed by qualified electricians.
4. If there is any damage on the housing or glass cover, should view it as disqualified product that cannot be used.
5. If the external flexible cable or cord of this luminaire is damaged, it shall be exclusively replaced by the manufacturer or his service agent or a similar qualified person in order to avoid a hazard.

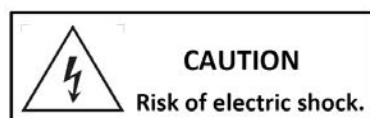
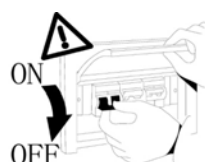

INSTALLATION STEPS:

1. Select the required position for the luminaire. Press the clamps on endcap and twist to release endcap from luminaire. Connect power supply to the quick release terminal.

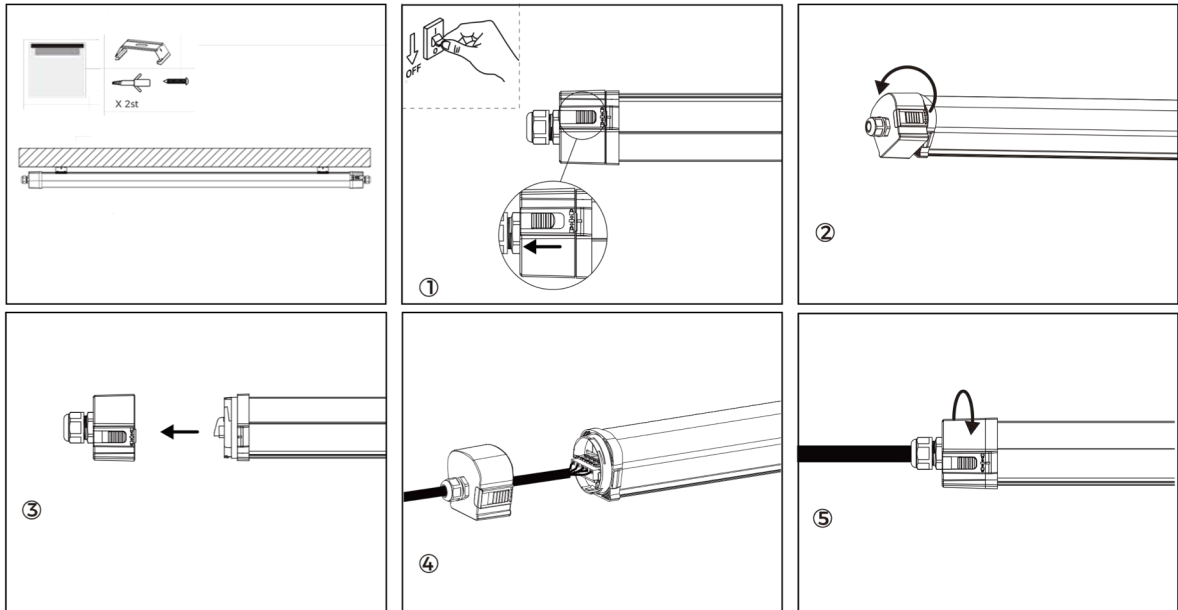

2. Twist the end cap and connect power supply to the quick release terminal.

- Mains supply LIVE (Brown) - L
- Mains supply NEUTRAL (Blue) - N
- Mains supply EARTH (Yellow/Green) - E

IMPORTANT: The luminaire is Class I and must be earthed.

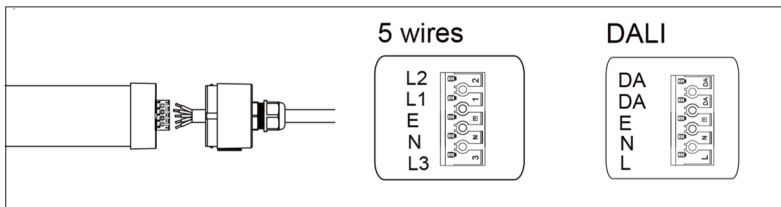

Follow the DALI configuration from manual of DALI control supplier.

3. Power adjustable if default power is not applicable. Art 365189 DALI version is single power.

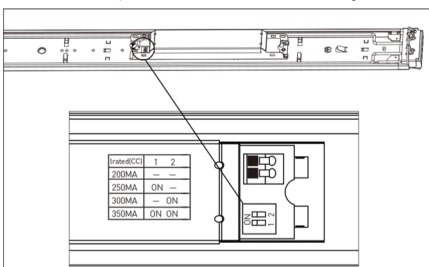

Rated	1200mm	1500mm	1	2
200mA	25W	35W	-	-
250mA	32W	44W	ON	-
300mA	38W	53W	-	ON
350mA	45W	63W	ON	ON

4. Linkable quantity

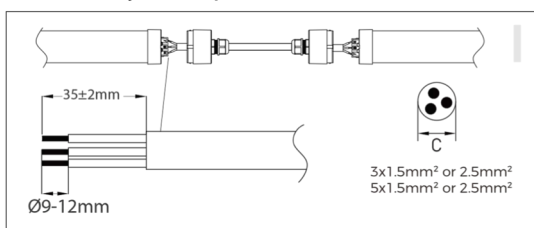

Input Voltage	Max Qty 1200mm		Max Qty 1500mm	
230VAC	25W	30 stk	35W	21 stk
230VAC	32W	23 stk	44W	17 stk
230VAC	38W	20 stk	53W	14 stk
230VAC	45W	17 stk	63W	12 stk

5. Switch on the power supply.